

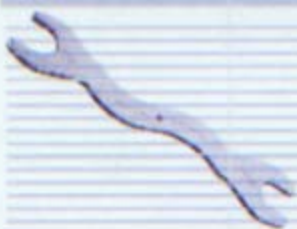

# → RG-1008 SERVICE MANUAL

# Scuba Max

→ Regulator Service Manual →



Professional SCUBA Diving Equipment

# SCUBA MAX

→ Tel: (909) 869-7977 Fax: (909) 595-8600

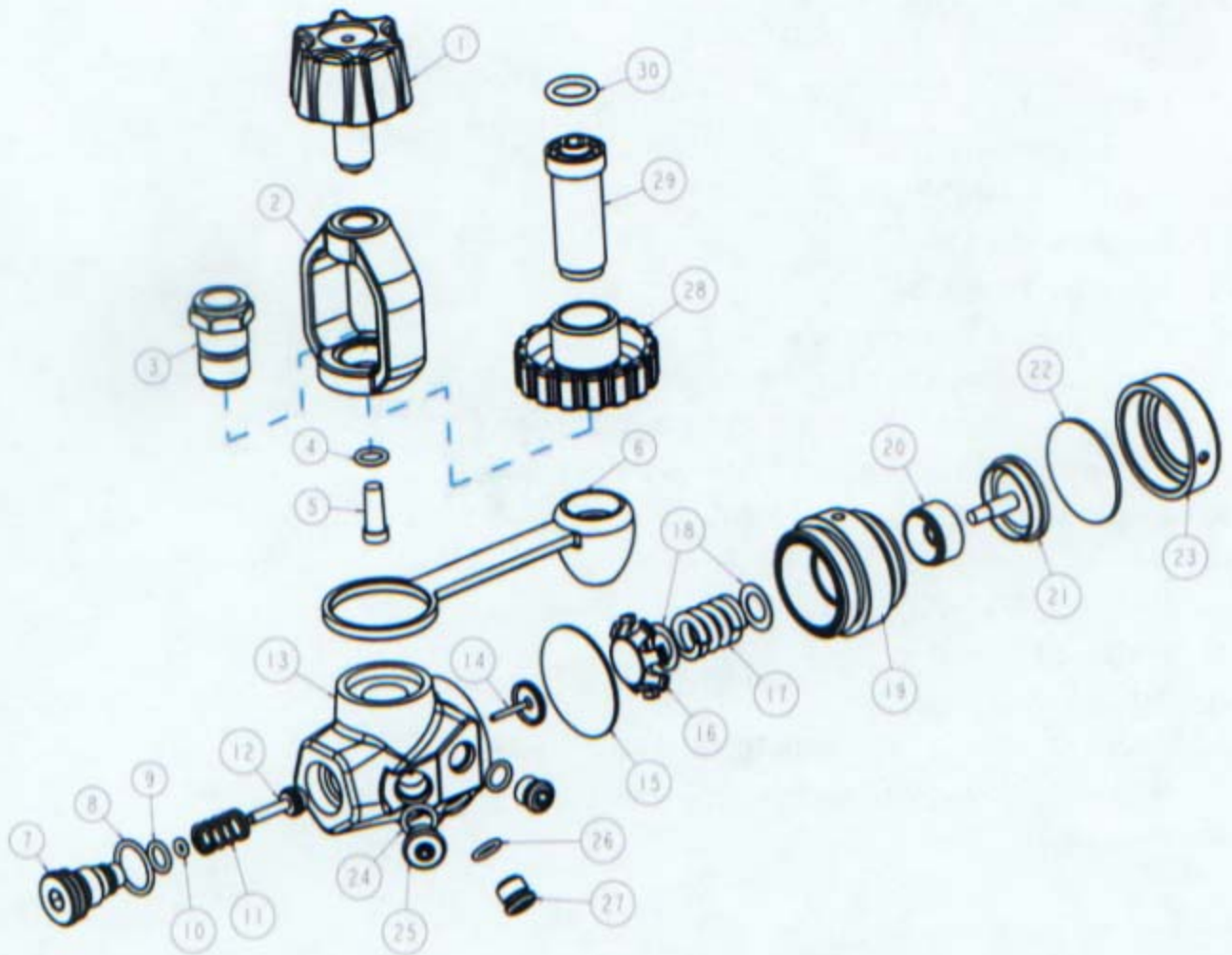

NO	ITEM NO	DESCRIPTION	QTY	NO	ITEM NO	DESCRIPTION	QTY
1	B-01-0080-01	YOKE KNOB	1	16	A-01-002-04	SPRING SEAT	1
2	F-01-002-01	YOKE	1	17	D-01-008-02	MAIN SPRING	1
3	C-01-008-01	YOKE RETAINER	1	18	P-01-005-02	PLASTIC WASHER	2
4	O-AS568-011-02	O-RING	1	19	C-01-008-04	DIAPHRAGM CLAMP	1
5	F-01-005-02	FILTER	1	20	C-01-008-05	ADJUST SCREW	1
6	A-01-005-01	DUST CAP	1	21	C-01-008-06	TRANS PISTON	1
7	C-01-008-02	BALANCE PLUG	1	22	A-01-008-01	SILICON DISK	1
8	O-AS568-016-01	O-RING	1	23	C-01-008-07	ENV CAP	1
9	O-AS568-011-02	O-RING	1	24	O-AS568-904-01	O-RING	2
10	O-AS568-006-02	O-RING	1	25	C-01-005-10	HP PLUG	2
11	D-01-008-01	SPRING	1	26	O-AS568-903-01	O-RING	3
12	B-01-002-02	HP SEAT	1	27	C-01-005-11	LP PLUG	3
13	F-01-008-01	MAIN HOUSING	1	28	B-01-002-03	DIN WHEEL - BK	1
14	C-01-008-03	LIFTER	1	29	C-01-008-08	DIN CONNECTOR	1
15	P-01-002-01	DIAPHRAGM	1	30	O-AS568-112-02	O-RING	1

## TABLE OF CONTENTS

- 1.0 Introduction
- 2.0 Specifications
  - 2.1 Torque Specifications
- 3.0 Service Kit List
  - 3.1 Service Tool List
- 4.0 First Stage Procedures
  - 4.1 Tools Required for First Stage Servicing
  - 4.2 Disassembly of the **RG-1008** First Stage
  - 4.3 Cleaning and Inspection of the First Stage
  - 4.4 Preliminary Assembly of the First Stage
  - 4.5 Set-up and Testing of the First Stage
  - 4.6 **DRY ENVIRONMENTAL STEP**
- 5.0 Helpful Hints
  - 5.1 Troubleshooting
  - 5.2 Parts Cleaning Recommendations
  - 5.3 Commonly Used Cleaning Solutions
  - 5.4 Handling Tips

### Before You Begin .....

Read these instructions completely before you begin servicing the regulator or filling whip.

These instructions are intended for people who have been **AUTHORIZED** by **SCUBAMAX** to repair **SCUBAMAX** Scuba equipment. If you are not so authorized - **STOP**.

## 1.0 INTRODUCTION

- 1.0.1 The procedures in this manual apply to the **SCUBAMAX RG-1008 1ST STAGE** Regulator , Refer to the exploded views as you read the service section of the manual. The Item Numbers referred to in the service section are those seen in the corresponding exploded view.



**! WARNING !**

**NEVER** reuse the diaphragm in the first stage. A used diaphragm will not clamp securely as required. A used diaphragm may come loose during

use, causing a severe regulator malfunction. This is true with all diaphragm first stages. Failure to heed this warning may result in serious injury or death.

**NEVER** tighten the hose fitting to the first stage with more than 40 in. lbs. (4.5 Nm) of torque. The inlet hose fitting will be weakened by over tightening. Failure to heed this warning may result in serious injury or death.

**NOTE:**

All **SCUBAMAX** Scuba Regulators have service kits available which contain the parts which must be changed at every annual service no matter what their condition. The standard annual service kit part numbers are shown in the parts list. All other parts not contained in these kits must be inspected by the technician and changed if necessary. Parts will be handled under warranty, only if they have failed due to problems with material or workmanship.



**! WARNING !**

**SCUBAMAX** Scuba Regulators are manufactured using materials suitable for use with oxygen enriched gases (i.e. Nitrox, etc.) providing the oxygen content does not exceed 40%. Equipment intended for enriched air (Nitrox) use, must not be used with regular compressed breathing air or other gases. Regulators intended for enriched air use, can be serviced only by technicians trained by one of the major oxygen enriched air training agencies. Failure to heed this warning may result in serious injury or death.

- 1.0.2** This manual gives breakdowns of regulator parts, equipment specifications, servicing instructions, troubleshooting recommendations, and guidelines for proper care of **SCUBAMAX** regulators. This manual is intended for use only by persons specially trained and authorized to service **SCUBAMAX** Scuba equipment.
- 1.0.3** Anyone attempting to service or repair **SCUBAMAX** Scuba regulators must have a thorough understanding of the principles of operation of scuba regulators and valves, as well as the appropriate mechanical ability. The technician must be properly trained in the safe use of compressed air and the various tools and cleaning solutions involved in

the procedures outlined in this manual.

1.0.4 The best source for current part numbers for any of the parts listed in this manual is your current parts and price list from **SCUBAMAX**.

1.0.5 If you have any questions, or need more information, contact your **SCUBAMAX** Scuba Sales Representative or **SCUBAMAX** Customer Service. You can e-mail you technical questions to **SCUBAMAX'S** mail box.

## 2.0 SPECIFICATIONS

### **SCUBAMAX** RG-1008

**AIR FLOW** .....33 cu.ft.(935 liters)/min.@ 1 atmosphere  
**INHALATION RESISTANCE** .....0.9" -2.0" (2.3 - 5.08 cm) w.c.@ 1 atmosphere  
(adjustable)  
**EXHALATION RESISTANCE** .....0.6" (1.52 cm) w.c.max.@ 1 atm.  
**RECOMMENDED LUBRICANT**LTl Christo-Lube 111







#### A. **SCUBAMAX** FIRST STAGE REGULATOR

**TYPE** ..... Balanced Diaphragm with or no - Dry  
Environmental Seal with Hydrostatic  
Transmitter  
**WEIGHT** ..... 2.1 lb.(.95 kg)  
**INTERSTAGE PRESSURE** .....130-145 psi (9-10 bar)(135 psi / 9.3  
bar,nominal)  
**# LOW PRESSURE PORTS** .....4 (3/8"-24 UNF)  
**# HIGH PRESSURE PORTS** .....2 (7/16"-20 UNF)  
**MATERIALS** .....Body ----- CDA-360 Brass  
O-rings ---- Buna-N

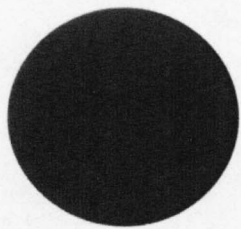



## 2.1 Torque Specifications:

<b>Description</b>	<b>Item #</b>	<b>Torque</b>
<b>DIAPHRAGM CLAMP</b>	<b>19</b>	<b>25-30 ft/lb(34-40 N.M)</b>
<b>DIN BOLT</b>	<b>29</b>	<b>23-25 ft/lb (31.19-33.90 N.M)</b>
<b>YOKE RETAINER</b>	<b>3</b>	<b>23-25 ft/lb (31.19-33.90 N.M)</b>
<b>HP BALANCE PLUG</b>	<b>7</b>	<b>2-3 ft/lb (3-4 Nm)</b>
<b>PORT PLUGS</b>	<b>25,27</b>	<b>35-40 In/lbs (3.96-4.52 N.M)</b>
<b>HOSE INLET END</b>		<b>2-3 ft/lb (3-4 Nm)</b>
<b>Hose outlet end</b>		<b>2-3 ft/lb (3-4 Nm)</b>
<b>2nd Stage Nut</b>		<b>1-2 ft/lb (2-3 Nm)</b>

### 3.0 SERVICE KIT LIST

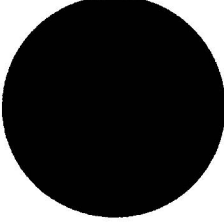
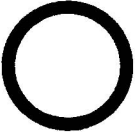
RG1008 YOKE SERVICE KIT				
DRAWING	NO	PART NO	DESCRIPTION	Q'TY
	4,9	O-AS568-011-02	O-RING 011 N90	1
	15	P-01-002-01	DIAPHRAGM	1
	8	O-AS568-016-01	O-RING 016 N70	1
	12	B-01-002-02	HP SEAT	1
	10	O-AS568-006-02	O-RING 006 N90	1
	24	O-AS568-904-01	O-RING 904 N90	2
	26	O-AS568-903-01	O-RING 903 N70	3

## RG1008 DIN SERVICE KIT

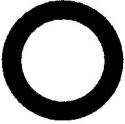
DRAWING	NO	PART NO	DESCRIPTION	Q'TY
	4,9	O-AS568-011-02	O-RING 011 N90	1
	15	P-01-002-01	DIAPHRAGM	1
	8	O-AS568-016-01	O-RING 016 N70	1
	12	B-01-002-02	HP SEAT	1
	10	O-AS568-006-02	O-RING 006 N90	1
	24	O-AS568-904-01	O-RING 904 N90	2
	26	O-AS568-903-01	O-RING 903 N70	3
	30	O-AS568-112-02	O-RING 112 N90	1



### 3.1 SERVICE TOOL LIST

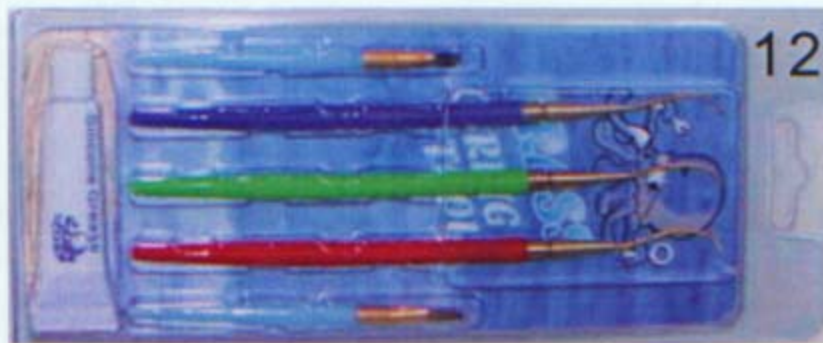
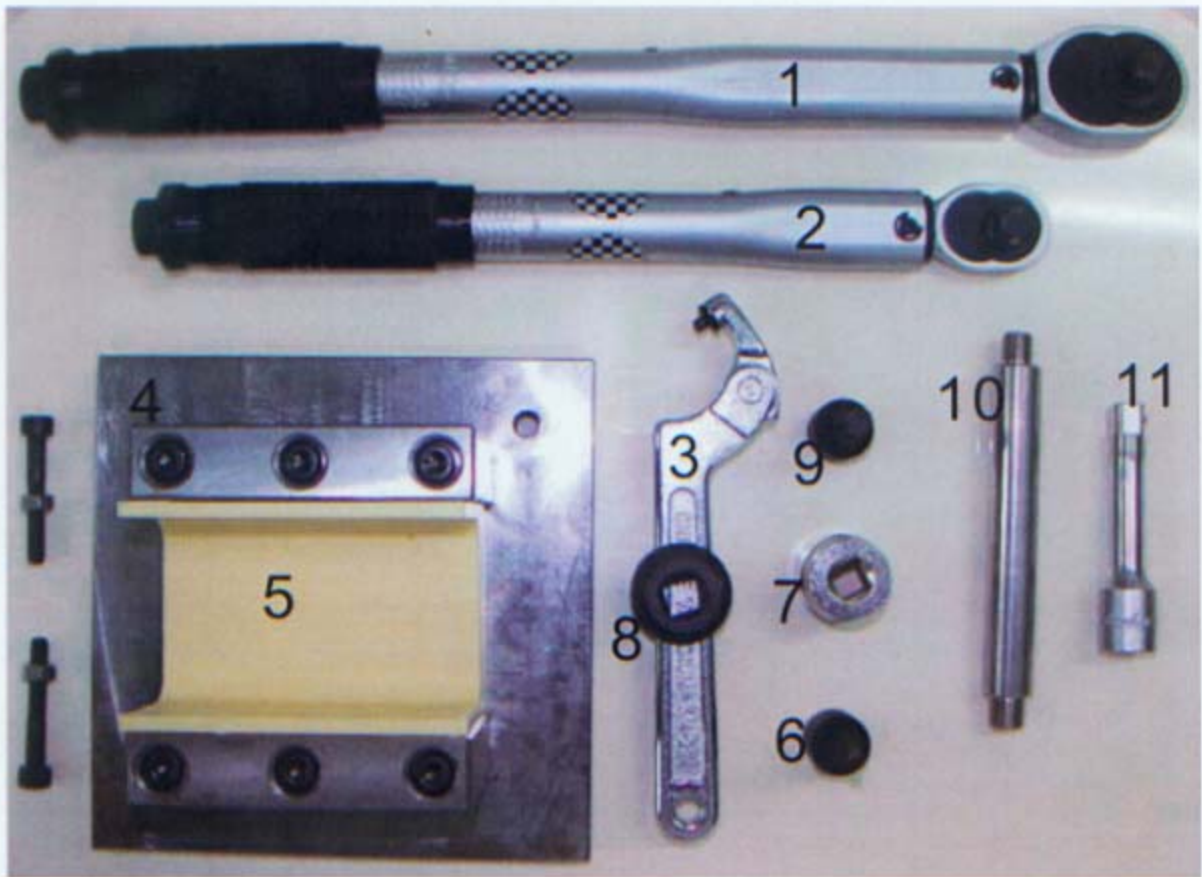

1	TORQUE WRENCH 19-110 N.M	2	TORQUE WRENCH 5-25 N.M
3	4MM PIN SPANNER	4	FIXTURE HOLDLE
5	FIXTURE BLOCK	6	4MM HEX BIT SOCKET
7	19MM HEX SOCKET	8	SPANNER HOLD SOCKET
9	1/4" HEX BIT SOCKET	10	STAINLESS HANDLE BAR
11	TORSION BAR	12	O-RING TOOL SET

## **4.0 SERVICE PROCEDURES FOR THE SCUBAMAX RG-1008**

### **4.0.1**

**Before you begin disassembly of the regulator, test the first and second stages for output pressures and leakage. Pre-testing in this way will help the technician to pinpoint any specific problems requiring repair.**

### **4.0.2**

**The work area must be clean and well lit, with clean compressed air available to blow sand and dirt from parts.**

## **4.1 TOOLS AND PARTS LIST REQUIRED FOR SCUBAMAX SERVICING**

- Fixture block (supply from **SCUBAMAX**) OR Soft-jawed bench vise (bench vise with rubber, plastic, aluminum or plastic jaw inserts)
- **PIN SPANNER AND HOLD SOCKET FOR DIAPHRAGM CLAMP(19)**
- **19MM HEX SOCKET FOR YOKE RETAINER(3)**
- **4MM HEX BIT SOCKET FOR PORT PLUG(25,27)**
- **1/4" HEX BIT SOCKET FOR HP BALANCE PLUG(7), ADJUST SCREW(20) , DIN BOLT(29)**
- **5~25N.M - 3/8" TORQUE WRENCH ADJUSTABLE**
- **19~110N.M - 3/8" TORQUE WRENCH ADJUSTABLE**
- **STAINLESS HANDLE BAR**
- **1st STAGE ANNUAL SERVICE KIT**
- **CLEAN SHOP RAGS**
  
- **LTI Christo-Lube 111<sup>®</sup>, or Dow-Corning 111<sup>®</sup> Silicone Grease**
- **Intermediate Pressure Testing Gauge**

## 4.2 DISASSEMBLY OF THE SCUBAMAX FIRST STAGE FOR OVERHAUL

To view all of the parts used in the SCUBAMAX first stage, look at the inside front cover of this manual. The bracketed numbers in the text refer to the corresponding circled item numbers on the exploded view drawing.

### 4.2.1

Use the 6" and 8" adjustable wrenches to loosen the hose nut from the port of 1st stage. Remove the hose assembly from the second stage. Inspect the hose assembly for any cuts or cracks, especially on the hose at the metal ferrules. Blow the interior bores of the hoses.

Replace the hose assembly if any cuts or cracks are found. Remove and discard the O-rings from each end of the hose. Clean, rinse, and blow-dry the interior bores of the hoses. Replace the hoses if necessary.

#### Note:

Hose Protectors are easier to slide back from the 1st stage end of the hose if they are twisted and pulled when the hose is still installed in the 1st stage. If a hose protector is particularly difficult to pull back, try removing the hose and soaking the hose protector end in hot water to soften it up. Temporarily reinstall the hose and try pulling and twisting the hose protector again.

### 4.2.2

Unscrew and remove the environmental end cap (23). Remove the silicone hydrostatic diaphragm (22). Remove the black hydro-transmitter (21).

### 4.2.3

Put the body into the fixture block or clamp carefully in a soft-jawed bench vise. Remove the yoke knob assembly (1) from the yoke (2). Use **19MM HEX SOCKET** to loosen and remove the yoke retainer (3) and the dust cap (6).

#### Note:

If the regulator has a DIN wheel, use a **1/4" HEX BIT SOCKET** to remove the DIN BOLT(29) and DIN wheel (35).

#### 4.2.4

Remove inlet filter (5). Remove and discard the filter O-ring (4), the DIN inlet O-ring (30) if the regulator is DIN equipped.

#### 4.2.4

Use a **4MM HEX BIT SOCKET** to remove all plugs (25,27) from the body. Discard the port plug O-rings. (24,26)

#### 4.2.5

**STAINLESS HANDLE BAR** screw in hp port. Put the body into the fixture block with the hp balance plug (7) facing up. Use a **1/4" HEX BIT SOCKET** to remove the hp balance plug assembly (8,9,10,11,12) from the body (13).

#### 4.2.6

Remove the **HP SEAT**(12) and **SPRING**(11). Remove and discard all O-rings from the **HP BALANCE PLUG**(7).



#### **! WARNING !**

If a sharp pick is used to remove the O-rings, it should be made from soft brass, not steel. **ANY** scratches left in the groove when removing O-rings will cause leaks.

#### 4.2.7

Use a pin spanner installed in the hole in the diaphragm clamping (19) to loosen and remove the diaphragm clamping from the body. The heel of the spanner can be wrapped with tape to help prevent damage to the chrome finish on the diaphragm cap.

#### 4.2.8

Use a **1/4" HEX BIT SOCKET** to remove the spring adjuster (20) from the diaphragm clamping (19). Remove the spring (17), spring washer(18), spring carrier (16), diaphragm (15) and lifter (14) from the body (13). Discard the diaphragm (15).

**NEVER** reuse the diaphragm in the first stage. A used diaphragm will not clamp securely as required. A used diaphragm may come loose during use, causing a severe regulator malfunction. This is true with all diaphragm first stages. Failure to heed this warning may result in serious injury or death.

### **4.3 Cleaning and Inspection of the 1st Stage**

#### **4.3.1**

**Clean all metal parts of the first stage in an ultrasonic cleaner or cleaning solution. See Section 5.3 for recommendations on cleaning solutions. Remove the O-rings before cleaning any metal parts since the soft O-ring material will absorb cleaning energy from the ultrasonic cleaner reducing its effectiveness. If major visible corrosion or deposits exist on parts, use a bristle brush, wooden, or plastic stick to rub the deposits off. Allowing acidic cleaning solutions to do all of the work if deposits are severe will result in damage to internal chrome plating which will make parts even more susceptible to future corrosion.**

#### **4.3.2**

**Remove the regulator parts from the cleaning solution. Rinse with clean fresh water , then blow internal passageways dry with clean , dry compressed air.**

#### **4.3.3**

**Inspect all O-ring grooves for scratches or wear. If the regulator was leaking air because of scratches or wear, replace the parts. If some corrosion deposits persist, carefully wipe them away with a plastic scrubbing cloth or plastic or wooden dowel. Blow any resulting dust out of the regulator parts.**

#### **4.3.4**

**Closely examine the sealing cones (orifices) in the Body (13) where the hp Seat (12) seal.**

### **4.4 PRELIMINARY ASSEMBLY OF THE FIRST STAGE**

**Correct order of assembly is extremely important! The diaphragm end MUST be assembled before the turret bolt end. Incorrect assembly order will result in damage to the first stage lifter (14) and hp seat (12). If the diaphragm end of the regulator is opened for any reason, such as replacing**

**the hp seat(12), the other end of the regulator (BALANCE PLUG) MUST BE DISASSEMBLED so that the diaphragm end can be re-assembled first.**

#### **4.4.1**

**To determine the identity of each O-ring in the Service Kit, remove them from the bag and use the O-ring Identification Chart on the front page of this manual. Lay each O-ring over its corresponding picture on the page and read the description. Before installing new O-rings into the regulator, lightly lubricate the O-rings with LTI Christo - Lube 111<sup>®</sup> (for enriched air regulators), or Dow-Corning 111<sup>®</sup> silicone grease. The most effective way to lubricate the kit O-rings is to put them in a small plastic bag with a pea sized amount of grease. Rub the O-rings and grease together in the bag until all the O-rings are coated evenly. Try not to wipe the lubrication off the O-rings when assembling them onto other parts.**

#### **4.4.2**

**Install the yoke retainer (3) into the yoke (2).**

#### **4.4.3**

**Install the filter(5) and the new O-ring (48) into the yoke retainer. Support the yoke retainer so that the body is facing up. Hand tighten the yoke, yoke retainer, into the body (10).**

**Note:**

**If the regulator has a DIN connection, install the DIN bolt (29) with a new O-ring (4,30), filter(5) and din wheel (28) into the body as described for the yoke assembly.**

#### **4.4.4**

**STAINLESS HANDLE BAR screw in hp port or place the body (13) carefully into a fixture so that the yoke retainer or DIN bolt is facing up. Tighten the yoke retainer or the din housing with a **19MM HEX SOCKET**, follow the Torque Specifications.**

#### 4.4.5

If the regulator has a DIN connection. Tighten the din bolt(29) with a **1/4" HEX BIT SOCKET**, follow the Torque Specifications.

#### 4.4.6

Position the body in the fixture or on table, the diaphragm opening faces up. Install the lifter (14) into the body(13). Install the new diaphragm (15) into the body(13).



**NEVER** reuse the diaphragm in the first stage. A used diaphragm will not clamp securely as required. A used diaphragm may come loose during use, causing a severe regulator malfunction. This is true with all diaphragm first stages. Failure to heed this warning may result in serious injury or death.

#### 4.4.7

Place the spring carrier (16) onto the center of the diaphragm. Place the main spring (17) and washer(18) onto the spring carrier (16). Screw the adjust screw (20) about two turns into the diaphragm clamping (19) (from the outside end of the diaphragm clamp).

#### 4.4.8

Place the diaphragm clamp over the top of the main spring (17) carefully to avoid pushing the spring and spring carrier out of position on the center of the diaphragm. Tighten the clamp down by hand as far as possible.

Use the pin spanner wrench to tighten the diaphragm clamping the rest of the way down. Tighten to 25-30 ft/lb (34-40 Nm) torque or until the edge of the diaphragm clamping and the body meet metal. This is essential to ensure that the diaphragm is securely clamped. Use a soft material as a cushion under the spanner to prevent marks from being made on the diaphragm clamp.

#### 4.4.9

Turn the body over carefully and position the body in the fixture or on table so that the turret end is faced up.

#### 4.4.10

Lightly lubricate the new O-rings from the annual service kit with LTI Christo-Lube 111<sup>®</sup>. Install O-rings (8,9,10) onto the balance plug (7).

Lightly lubricate the stem of the HP seat (12). Snap the end of the spring (11) over the ledge on the HP seat. Insert the valve and spring into the balance plug (7).

#### 4.4.11

Install the turret bolt and valve assembly onto the end of the regulator.

#### 4.4.12

Take care to insure that the HP seat(12) fits over the stem of the lifter (14) as you install the assembly into the body.

#### 4.4.13

Screw the balance plug (7) assembly into the body with a **1/4" HEX BIT SOCKET**. Tighten to 2-3 ft/lb (3-4 Nm) torque or just until you feel firm metal to metal contact stopping the rotation of the parts.

#### 4.4.14

Install the dust cap (6) and yoke knob (1) onto the yoke. Install new O-rings (24,26) from the kit onto port plugs (25,27) and install the port plugs into the appropriate ports.

Tighten the port plugs with a **4mm HEX BIT SOCKET**, follow the Torque Specifications.

### 4.5 SET-UP AND TESTING THE FIRST STAGE



**Note:**

**The RG-1008 regulator has a DIAPHRAGM BALANCE 1st stage. For safety, test the first stage regulator with at least one second stage installed. The demand valve on the second stage acts as a relief valve in case of a malfunction.**

**4.5.1**

**Install an intermediate pressure test gauge into one of the low-pressure ports of the first stage, and a functional 2nd stage into another low pressure port. Plug any remaining open outlet ports with suitable port plugs.**

**NOTE:**

**The following test determines the regulator's lock-up pressure (the pressure put out by the first stage during a no flow condition).**

**4.5.2**

**Attach the regulator to a tank valve giving a source pressure of between 2700 and 3500 psig (186-240 Bar).**

**4.5.3**

**Turn the supply air on slowly while listening for any unusual air leaks. If any are heard, turn the air off immediately and determine the source of the leak. If no leaks are found, watch the intermediate pressure gauge reading rise as you continue turning the air on slowly. It should stop before 145 psig (10 bar) since the intermediate pressure has not been set yet.**

**4.5.4**

**If the pressure gauge continues to rise above 155 psig (10.4 bar), turn the air supply off immediately and inspect the regulator to determine the cause.**

**4.5.5**

**4.5.5 Depress the purge cover fully, then release it several times to clear particles from the regulator, and to work the internal parts into place. To prevent uncontrolled free flows after pushing the purge cover, keep the deflator knob on the second stage in the "-"(negative position).**

#### 4.5.6

The pressure range for **SCUBAMAX** Regulators is 130-145 psi( 9-10 bar) Use a **1/4" HEX BIT SOCKET** installed into the **SPRING ADJUSTER (20)** to change the intermediate pressure. Turn the spring adjuster clockwise in 1/8-turn steps to raise the intermediate pressure, and counter clockwise in 1/8 - turn steps to lower it. Always push the purge cover briefly between each adjustment step. Do not push on the diaphragm with the tip of the Allen wrench, or a false (higher) reading will occur. The optimal intermediate pressure for **SCUBAMAX** regulators is 135 psi (9.3 bar), but any setting between 130 and 145 psi (9-10 bar) will provide good stable performance..

#### 4.5.7

After reaching the proper pressure setting, push the purge cover on the second stage again several times and watch how the intermediate pressure reading responds. When the purge cover on the second stage is depressed, the intermediate pressure reading will drop. When the purge cover is released, the pressure should return immediately to the proper lock-up pressure and stay there.

#### 4.5.8

Let the regulator sit with the tank valve turned on for several minutes. The intermediate pressure reading may rise about 3 psi in the first three seconds after lock-up, but after that it should not rise more than another 4 psi (.3 bar) in five minutes. If it rises more than 4 psi refer to the Trouble-shooting Section 5.1 of this manual.

#### Note:

Never set the output pressure of the first stage above 145 psig (10 bar).

### 4.6 FOR THE REGULATOR WITH DRY ENVIRONMENTAL SEAL WITH HYDROSTATIC TRANSMITTER

#### 4.6.1

To finish installing the **END CAP(23)** on the first stage, the pressure to the first stage must be left on to position all internal parts properly.

#### **4.6.2**

**With the regulator pressurized, insert the hydro transmitter (21) into the body assembly.**

#### **4.6.3**

**Install the new clear hydrostatic diaphragm (22) into the recess in the diaphragm clamp(19) over the hydro transmitter.**

#### **4.6.4**

**Install the end cap (23) onto the diaphragm clamp (19). Use a clean rag to help grasp the end cap. Tighten the end cap firmly. Use enough force so that the end cap cannot be loosened easily by hand. Use the Pin Spanner to tighten the end cap. Use a soft material as a cushion under the spanner to prevent marks from being made on the end cap.**

#### **4.6.5**

**Push the clear hydrostatic diaphragm (22) briefly with one finger while watching the intermediate pressure gauge. The pressure should rise about 1 psi for every pound of force. For example, five or ten psi (.35 - .7 bar) increase in intermediate pressure when the diaphragm is pushed with five or ten pounds.**

#### **4.6.6**

**Turn off the supply pressure and depress the purge cover to release the air from the second stage. When the intermediate pressure drops to zero you should see the clear hydrostatic diaphragm (22) pull into the body assembly. If the regulator is re-pressurized, the clear diaphragm will push out to the flat position. If (by mistake) the end cap (23) is loosened and then re-tightened without pressure applied to the first stage, the clear diaphragm will bulge outwards when the regulator is under pressure. If this condition exists, follow steps 4.6.1 to 4.6.5.**

## 5.0 HELPFUL HINTS

### 5.1 TROUBLESHOOTING

<b>POSSIBLE CAUSE</b>	<b>RECOMMENDED ACTION</b>
<b>Inlet filter clogged.</b>	<b>Replace the filter.</b>
<b>Air supply to 1st stage insufficient.</b>	<b>Verify the supply air pressure. Make sure the customer had the air valve turned all the way on during the dive.</b>
<b>1st improperly adjusted.</b>	<b>Refer to sections 4.5 of this manual.</b>

#### A. CREEPING INTERMEDIATE PRESSURE:

<b>POSSIBLE CAUSE</b>	<b>RECOMMENDED ACTION</b>
<b>Damaged or worn 1st stage seat (12).</b>	<b>Replace seat</b>
<b>Nick in sealing surface of Body Orifice (13)</b>	<b>Replace Body or Buff out Scratch</b>
<b>Worn O-ring (10) on HP valve stem.</b>	<b>Replace O-ring</b>
<b>Scratch in groove where O-ring (10) seals</b>	<b>Replace balance plug (7)</b>
<b>Seat (12) has not taken shape of Orifice yet.</b>	<b>Let the Regulator sit with the pressure on for a few minutes and measure pressure again.</b>

#### B. HIGH FREQUENCY HUMMING OR BUZZING DURING INHALATION:

<b>POSSIBLE CAUSE</b>	<b>RECOMMENDED ACTION</b>
<b>Harmonic resonance between the springs and other 1st stage components.</b>	<b>Remove the main spring (17) flip it over and re-install.</b>
	<b>Replace spring or other components</b>

	until resonance stops.
--	------------------------

## **5.2 PARTS CLEANING RECOMMENDATIONS**

### **5.2.1**

**Regulators that see heavy use, particularly those used in salt water, often require extra effort to remove dirt and corrosion from the parts of the regulator. Some suggested cleaning solutions are listed at the end of this section, and there are probably many others being used successfully. The following are a few general suggestions we can make.**

### **5.2.2**

**Don't expect your cleaning solution to do all the work in a matter of seconds. If the solution cleans extremely rapidly, it is probably too strong and is etching the finish on the parts. Use a wooden or plastic stick or a soft bristle brush to help get rid of the thickest deposits. Take special care not to damage orifice sealing areas.**

### **5.2.3**

**Soft parts absorb ultrasonic energy. Remove all O-rings and seals from metal parts before cleaning them. If possible, do not clean plastic parts with the metal parts, or at least understand that every plastic part you put into the ultrasonic cleaner is slowing down the ultrasonic cleaning process for the rest of the parts.**

### 5.3 COMMONLY USED CLEANING SOLUTIONS

<b>SOLUTION</b>	<b>COMMENTS</b>
<b>Hot Soapy water</b>	<b>Preferable. Good for plastic, silicone and plated metal parts.</b>
<b>Vinegar and water (equal part solution) (weaker solution in Ultrasonic Cleaner)</b>	<b>Ingredients easily available. Approx. 15 min. cleaning time. May damage chrome finish. Never use on plastic parts. Vinegar dissolves the plastics in most polymers making them brittle and more prone to breakage.</b>
<b>Simple Green R and Water</b>	<b>Simple Green is a readily available degreaser. Read the product label for mixing ratios with water.</b>
<b>Cleaning solutions recommended by ultrasonic cleaner manufacturers</b>	<b>The preferred choice. Check with the manufacturer for strengths and recommended uses for their cleaners. Choose soap solutions over acidic ones.</b>

### 5.4 HANDLING TIPS

**How your customers treat their regulators will directly influence the unit's function and durability.**

**Following are a few tips that you can pass on to your customers to help assure the durability of their SCUBAMAX Scuba Regulator.**

#### A. PRE-DIVE CHECKS:

##### 5.4.1

**Check the hoses and hose connections for cuts, abrasions or other signs of damage before mounting the regulator on the tank valve. Slide the hose protectors back to inspect the areas of the hose normally covered.**

**Be sure all hose connections are tight.**

**5.4.2**

**Just before mounting the regulator on the valve , always turn the valve on briefly to blow any trapped water out of the valve . There is often salty water trapped in the outlet side of the valve . This entrapped salt water being blown through the interior of the regulator is the number one source of internal corrosion and problems with Scuba regulators.**

**5.4.3**

**Before turning on the tank air valve , check to make sure that the yoke nut or DIN connection is tight and the regulator body is aligned properly , with no kinks in the hoses.**

**5.4.4**

**Turn the tank valve on slowly and listen for leaks . If any leaks are found , replace or repair parts as recommended.**

**5.4.5**

**Never lift the tank/BCD assembly by the regulator or hoses.**

**5.4.6**

**Surface-test the regulator by breathing lightly through the mouthpiece . Depressing the purge button above the water's surface is not an effective or thorough method for testing the function of the regulator.**

**B.POST-DIVE CARE:**

**5.4.7**

**After the dive , blow all water out of the dust cap with clean dry air or dab the water out with an absorbent cloth and place the cap securely on the regulator inlet . On multiple tank dives , use great care to keep salt water out of the regulator inlet when tanks are changed . Neglecting these simple procedures is another great cause of corrosion and wear in Scuba regulators .**

**5.4.8**

**With the dust cap securely in place , rinse the first and second stages in**

**clean fresh water. DO NOT depress the purge button before or during rinsing since this may introduce water into the second stage and the low-pressure hose . Shake or blow all excess water from the second stage and allow the entire regulator to air-dry before storing.**

#### **5.4.9**

**Store regulator in a clean bag or storage box , away from sunlight , excessive heat and humidity.**